

AK 3001/.. FD - 5,0 - slade grey

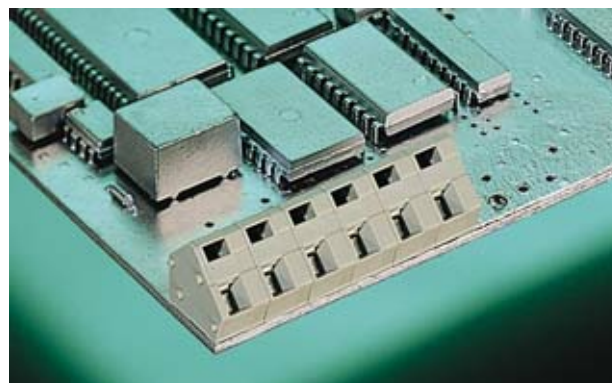

1-n poles, Spacing 5,0 mm adjustable to 5,08 mm insert required no. of poles ..

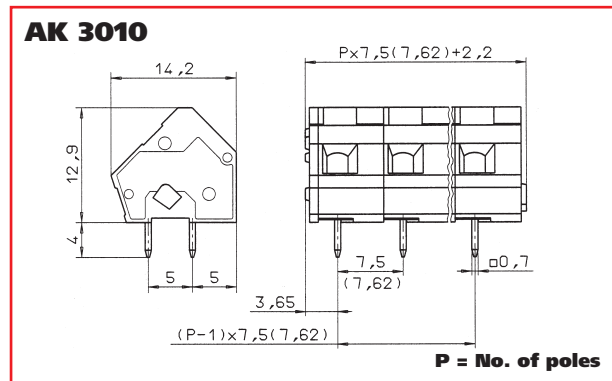

AK 3010/.. - 7,5 - slade grey

1-n poles, Spacing 7,5 mm adjustable to 7,62 mm insert required no. of poles ..

Ratings:

			
	UL 1059	CSA 22.2 No. 158	EN 60998
Rated Voltage	300 V	300 V	250 V
Rated Current	16 A	16 A	24 A (T60)
Wire Size	AWG 28-14	AWG 28-14	2,5 mm ²
Test Voltage			2,0 kV

Max. Rated Cross Section

Single Wire (solid)	2,5 mm ²
Stranded Wire (flexible)	2,5 mm ²
Stranded wire with Ferrules	1,5 mm ²



Dimensions

Spacing	5,0 mm (5,08 mm)
PCB Hole Diameter	1,0 mm (2x)
Stripped Length	6,0 mm

Materials

Insulating Material	PA
Flammability Class	UL94 V-0
Temperature Range	-30°C/+105°C
Cage clamp	stainless steel
Wire Guard	Cu
Colour	
slade grey	RAL 7032

Ratings:

			
	UL 1059	CSA 22.2 No. 158	EN 60998
Rated Voltage	300 V	300 V	750 V
Rated Current	16 A	16 A	24 A (T60)
Wire Size	AWG 28-14	AWG 28-14	2,5 mm ²
Test Voltage			3,0 kV

Max. Rated Cross Section

Single Wire (solid)	2,5 mm ²
Stranded Wire (flexible)	2,5 mm ²
Stranded wire with Ferrules	1,5 mm ²

Dimensions

Spacing	7,5 mm (7,62 mm)
PCB Hole Diameter	1,0 mm (2x)
Stripped Length	6,0 mm

Materials

Insulating Material	PA
Flammability Class	UL94 V-0
Temperature Range	-30°C/+105°C
Cage clamp	stainless steel
Wire Guard	Cu
Colour	
slade grey	RAL 7032