

STL(Z) 950 VERTICAL

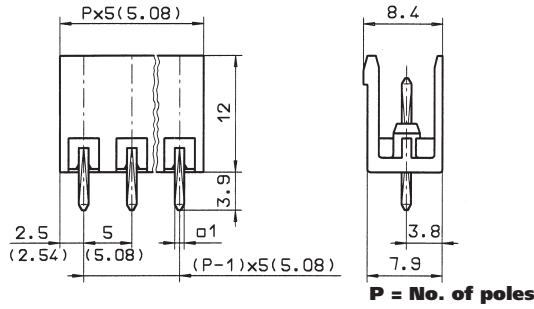

STL(Z) 950 HORIZONTAL

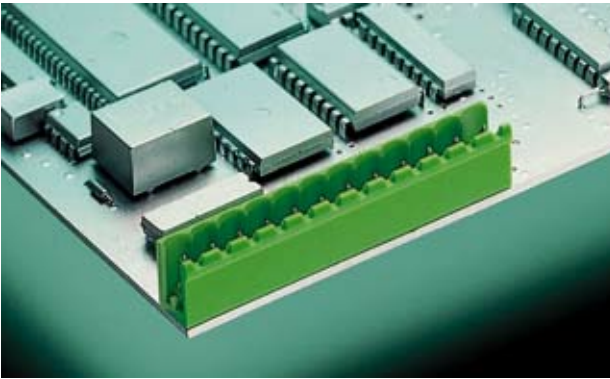
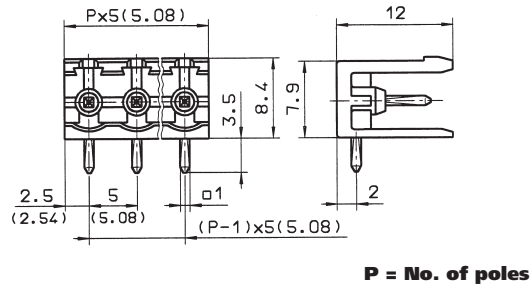

STL(Z) 950/.. - 5,0 (5,08) - V - green

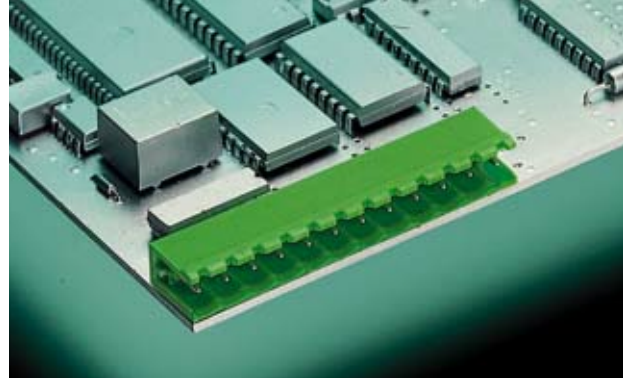

2-24 poles, Spacing 5,0 mm or 5,08 mm
insert required no. of poles ..





STL(Z) 950/.. - 5,0 (5,08) - H - green

2-24 poles, Spacing 5,0 mm or 5,08 mm
insert required no. of poles ..

Ratings:

			
	UL 1059	CSA 22.2 No. 158	DIN VDE 0627
Rated Voltage	300 V	300 V	250 V
Rated Current	15 A	15 A	12 A (T60)
Rating Impulse Voltage/Dirt Level			4 kV/3

Ratings:

			
	UL 1059	CSA 22.2 No. 158	DIN VDE 0627
Rated Voltage	300 V	300 V	250 V
Rated Current	15 A	15 A	12 A (T60)
Rating Impulse Voltage/Dirt Level			4 kV/3

Dimensions

Spacing	5,0 mm (5,08 mm)
PCB Hole Diameter	1,4 mm

Materials

Insulating Material	PA
Flammability Class	UL94 V-0
Temperature Range	-30°C/+105°C
Contact Pin	Cu

Colour

green	RAL 6018
-------	----------

Dimensions

Spacing	5,0 mm (5,08 mm)
PCB Hole Diameter	1,4 mm

Materials

Insulating Material	PA
Flammability Class	UL94 V-0
Temperature Range	-30°C/+105°C
Contact Pin	Cu

Colour

green	RAL 6018
-------	----------